

SUPERPLAN CLASSIC

- Exclusive, elegant design
- Made of KALDEWEI steel enamel
- Waste cover integrated almost flush into the shower surface (only in combination with the KA 90 waste fittings)



Similar illustration

Model 399	KA 90 horizontal	KA 90 flat	KA 90 vertical
Total height	105	85	49
Fitting height	80	60	80

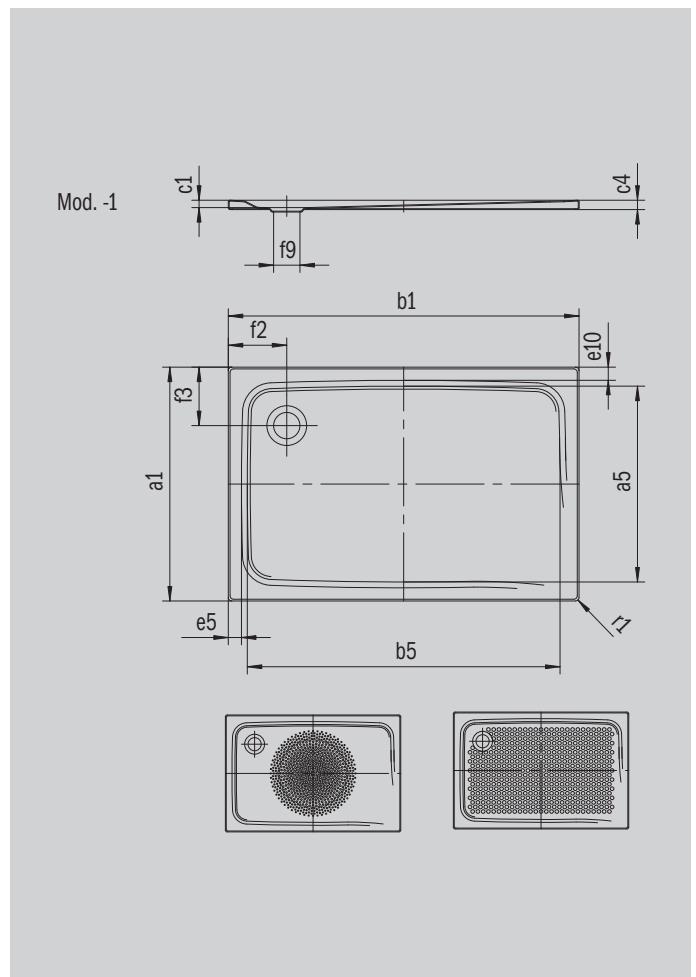

Model		399-1
External length [mm]	a_1	1200 mm
Internal length [mm]	a_5	1070 mm
External width [mm]	b_1	1200 mm
Internal width [mm]	b_5	1070 mm
Depth inside [mm]	c_1	25 mm
Height of rim [mm]	c_4	32 mm
Width of rim	e_{10}, e_5	50; 50 mm
Diameter of waste hole [mm]	f_9	Ø 90 mm
Distance bath edge to centre of waste hole [mm]	f_2, f_3	200; 200 mm
External radius [mm]	r_1	12 mm
Net weight [kg]		37 kg
Diameter of anti-slip [mm]		Ø 588 mm
Full anti-slip		1060 x 1105 mm
ANTI-SLIP SECURE PLUS		full base

Subject to technical alterations, tolerances and errors. Similar illustration.

KALDEWEI